

B AC Motors

S.C. Brake Motor 15W (□80mm)

15W

Speed Control Brake Motor 15W(□80mm)

Motor 사양

Model 8SBDG*-15□: Gear Type Shaft 8SBDG*-15: D-Cut Type Shaft	Output W	Voltage V	Frequency Hz	Poles	Duty	Speed Range r/min	Starting Torque		Permissible Torque				Capacitor μF / VAC
							kgfcm	N.m	1200r/min		90r/min		
Lead Wire Type									kgfcm	N.m	kgfcm	N.m	
8SBDG1(A)-15□	15	1φ110	60	4	30min.	90-1700	0.85	0.085	1.40	0.140	0.50	0.050	6.0 / 250
8SBDG2(D)-15□	15	1φ220	60	4	30min.	90-1700	0.85	0.085	1.40	0.140	0.50	0.050	1.5 / 450
8SBDGE-15□	15	1φ220	50	4	30min.	90-1400	0.75	0.075	1.30	0.130	0.48	0.048	1.5 / 450
		0.85					0.085	1.40	0.140	0.52	0.052		

- 1) 모터 모델명 * 자리에는 전압코드가, □ 안에는 부착되는 감속기의 모델 타입명이 들어갑니다.
- 2) 전압코드 A, D, E는 TP(Thermal Protector) 부착 사양입니다.
- 3) Gear Type Shaft는 감속기 부착용이며 D-Cut Type Shaft는 모터 단독 사용시의 출력축 입니다.

감속기 부착 시 최대허용토크

Motor Model	Gear box Model	회전 속도 r/min	전압 V	주파수 Hz	감속비	3	3.6	5	6	7.5	9	10	12.5	15	18	20	25	30	36	40	50	60	75	90	100	120	150	180	200	250	300	360			
8SBDG*-15G	8GBK □BMH	1200	110	60	kgfcm	3.4	4.1	5.7	6.8	8.5	10.2	11.3	14.2	17.0	20.4	20.4	25.6	30.7	36.8	40.9	46.2	55.4	69.3	80.0	80.0	80.0	80.0	80.0	80.0	80.0	80.0	80.0	80.0		
					N.m	0.33	0.40	0.56	0.67	0.83	1.00	1.11	1.39	1.67	2.00	2.00	2.50	3.00	3.61	4.01	4.53	5.43	6.79	7.84	7.84	7.84	7.84	7.84	7.84	7.84	7.84	7.84	7.84	7.84	7.84
					kgfcm	3.4	4.1	5.7	6.8	8.5	10.2	11.3	14.2	17.0	20.4	20.4	25.6	30.7	36.8	40.9	46.2	55.4	69.3	80.0	80.0	80.0	80.0	80.0	80.0	80.0	80.0	80.0	80.0	80.0	80.0
		N.m			0.33	0.40	0.56	0.67	0.83	1.00	1.11	1.39	1.67	2.00	2.00	2.50	3.00	3.61	4.01	4.53	5.43	6.79	7.84	7.84	7.84	7.84	7.84	7.84	7.84	7.84	7.84	7.84	7.84	7.84	7.84
		kgfcm			3.4	4.1	5.7	6.8	8.5	10.2	11.3	14.2	17.0	20.4	20.4	25.6	30.7	36.8	40.9	46.2	55.4	69.3	80.0	80.0	80.0	80.0	80.0	80.0	80.0	80.0	80.0	80.0	80.0	80.0	80.0
		N.m			0.33	0.40	0.56	0.67	0.83	1.00	1.11	1.39	1.67	2.00	2.00	2.50	3.00	3.61	4.01	4.53	5.43	6.79	7.84	7.84	7.84	7.84	7.84	7.84	7.84	7.84	7.84	7.84	7.84	7.84	7.84
	90	110	60	kgfcm	1.2	1.5	2.0	2.4	3.0	3.6	4.1	5.1	6.1	7.3	7.3	9.1	11.0	13.1	14.6	16.5	19.8	24.8	29.7	33.0	39.6	49.5	59.4	66.0	80.0	80.0	80.0	80.0	80.0		
				N.m	0.12	0.14	0.20	0.24	0.30	0.36	0.40	0.50	0.60	0.71	0.72	0.89	1.07	1.29	1.43	1.62	1.94	2.43	2.91	3.23	3.88	4.85	5.82	6.47	7.84	7.84	7.84	7.84	7.84		
				kgfcm	1.2	1.5	2.0	2.4	3.0	3.6	4.1	5.1	6.1	7.3	7.3	9.1	11.0	13.1	14.6	16.5	19.8	24.8	29.7	33.0	39.6	49.5	59.4	66.0	80.0	80.0	80.0	80.0	80.0	80.0	
		N.m	0.12	0.14	0.20	0.24	0.30	0.36	0.40	0.50	0.60	0.71	0.72	0.89	1.07	1.29	1.43	1.62	1.94	2.43	2.91	3.23	3.88	4.85	5.82	6.47	7.84	7.84	7.84	7.84	7.84	7.84			
		kgfcm	1.3	1.5	2.1	2.5	3.2	3.8	4.2	5.3	6.3	7.6	7.6	9.5	11.4	13.7	15.2	17.2	20.6	25.7	30.9	34.3	41.2	51.5	61.8	68.6	80.0	80.0	80.0	80.0	80.0	80.0			
		N.m	0.12	0.15	0.21	0.25	0.31	0.37	0.41	0.52	0.62	0.74	0.74	0.93	1.12	1.34	1.49	1.68	2.02	2.52	3.03	3.36	4.04	5.05	6.05	6.73	7.84	7.84	7.84	7.84	7.84	7.84			

Motor Model	Gearbox Model	회전속도 r/min	전압 V	주파수 Hz	감속비	10	12	15	18	25	30	36	50	60
8SBDG*-15W	8WD □BL/□BR/□BRL	1200	110	60	kgfcm	11.5	13.4	16.2	18.6	24.5	27.7	32.3	42.0	46.2
					N.m	1.13	1.32	1.58	1.83	2.40	2.72	3.16	4.12	4.53
					kgfcm	11.6	13.9	17.4	20.9	29.1	34.9	41.8	58.1	69.7
		N.m			1.14	1.37	1.71	2.05	2.85	3.42	4.10	5.69	6.83	
		kgfcm			11.5	13.4	16.2	18.6	24.5	27.7	32.3	42.0	46.2	
		N.m			1.13	1.32	1.58	1.83	2.40	2.72	3.16	4.12	4.53	
	90	110	60	kgfcm	4.1	4.8	5.8	6.7	8.8	9.9	11.5	15.0	16.5	
				N.m	0.40	0.47	0.57	0.65	0.86	0.97	1.13	1.47	1.62	
				kgfcm	4.1	4.8	5.8	6.7	8.8	9.9	11.5	15.0	16.5	
		N.m	0.40	0.47	0.57	0.65	0.86	0.97	1.13	1.47	1.62			
		kgfcm	4.3	5.0	6.0	6.9	9.1	10.3	12.0	15.6	17.2			
		N.m	0.42	0.49	0.59	0.68	0.89	1.01	1.17	1.53	1.68			

- 1) 모터 모델명 * 자리에는 전압코드가 들어갑니다.
- 2) 감속기 모델명 □ 안에는 감속비가 들어갑니다.
- 3) 위의 표에서 색칠된 범위의 감속비를 선택했을 때 감속기의 출력축은 모터의 출력축과 같은 방향으로 회전합니다. 흰색 바탕 범위의 감속비에서는 감속기 출력축은 모터 출력축의 회전방향과 반대방향으로 회전합니다.
- 4) 회전속도(r/min)는 모터의 동기회전속도(50Hz:1500r/min, 60Hz:1800r/min)를 감속비로 나누어 계산합니다. 실제 회전속도는 부하의 크기에 따라 표시보다 2~20% 정도 느립니다.

Dimensions

MOTOR ONLY

- MOTOR MODEL: 8SBDD□-15 (NO FAN)

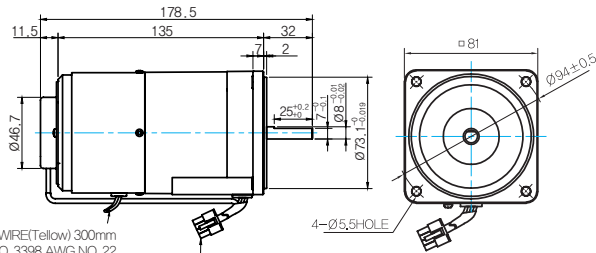

LEAD WIRE(Yellow) 300mm
UL STYLE NO.3398 AWG NO.22
380V 이상 NO.3613 AWG NO.22

LEAD WIRE ASS'Y 300mm
MOTOR UL STYLE NO.3271 AWG NO.20
T,G UL STYLE NO.1007 AWG No.22

- MOTOR OUTPUT SHAFT

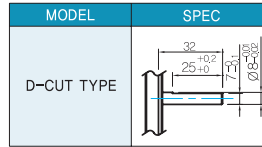

중간감속기

- MODEL: 8XD10□□

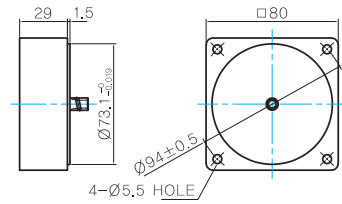

GEARED MOTOR

G TYPE GEARBOX

- MOTOR MODEL: 8SBDG□-15G (NO FAN)

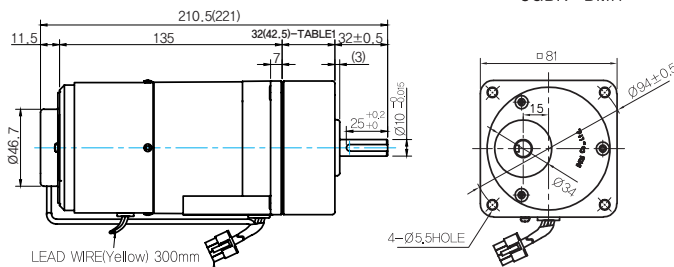

LEAD WIRE(Yellow) 300mm
UL STYLE NO.3398 AWG NO.22

LEAD WIRE ASS'Y 300mm
MOTOR UL STYLE NO.3271 AWG NO.20
T,G UL STYLE NO.1007 AWG No.22

- GEARBOX MODEL:
8GBK□BMH

- GEARBOX OUTPUT SHAFT

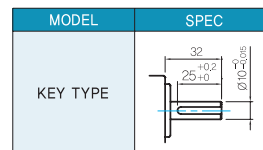

- KEY SPEC

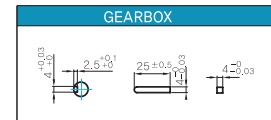

- 32(42.5)-Table1

SIZE(mm)	GEAR RATIO
32	8GBK3BMH - 8GBK18BMH
42.5	8GBK20BMH - 8GBK360BMH

W TYPE GEARBOX

- MOTOR MODEL:
8SBDG□-15W (NO FAN)

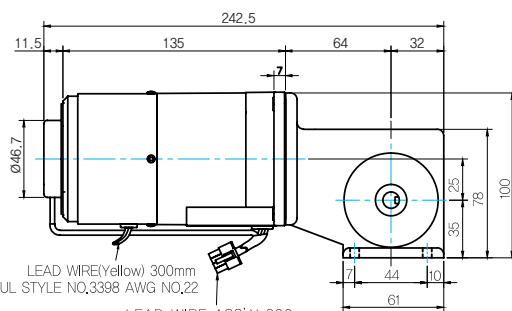

LEAD WIRE(Yellow) 300mm
UL STYLE NO.3398 AWG NO.22

LEAD WIRE ASS'Y 300mm
MOTOR UL STYLE NO.3271 AWG NO.20
T,G UL STYLE NO.1007 AWG No.22

- GEARBOX MODEL:
8WD□BL/BR/BRL

- KEY SPEC

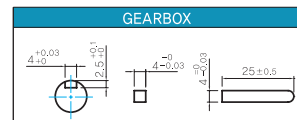

WEIGHT

PART	WEIGHT(Kg)	
MOTOR	2.1	
GEAR BOX	8GBK3BMH ~ 8GBK18BMH	0.56
	8GBK20BMH ~ 8GBK40BMH	0.65
	8GBK50BMH ~ 8GBK360BMH	0.72
	8WD□BL/BR/BRL	0.68
	8XD10□□	0.45

B AC Motors

S.C. Brake Motor 15W (□ 80mm)

Motor Images

